

## NEMP-TTG-250KV

### (Large sized NEMP Simulator)

- Nuclear EMP(NEMP) Simulator is used to simulate EMP signal which is reached on the earth surface by the nuclear weapon explodes at high-altitude(HEMP). NEMP Simulator can be used for EMP radiation immunity test for various electronic devices or systems by artificially creating EMP generation environment.
- Replex have developed a NEMP simulator using a high voltage pulse generator based on Tesla transformer and triangular-type radiation system. The applied Tesla transformer has a very high voltage gain(about 1: 250) and can generate high voltages even at low input voltages. Because of this feature, the power supply for driving the Tesla transformer is digitally controllable, so the polarity and magnitude of the generated signal can be easily adjusted.
- Replex's satisfies MIL-STD-461 E/F/G RS105 test requirements.
- NEMP-TTG-250kV is designed for non- permanent installation either in a large anechoic chamber or open area test site. But, it is optimized to be installed in a large anechoic chamber.

#### ■ Features

- Order production according to EUT size
- Maximum electric field : 50kV/m or more
- E-field Variable : 5kV/m ~ Max. E-field Strength
- E-field Polarity : Plus(+), Minus(-)
- Rise Time (10~90%) : 1.8ns ~ 2.8ns
- Pulse Width (FWHM) : 18ns ~ 28ns
- Peak value of the E-field in the Test Area :  $0\text{dB} \leq \text{magnitude} \leq 6\text{dB}$  above limit
- Insulation : N<sub>2</sub>(Nitrogen) gas , Transformer Oil

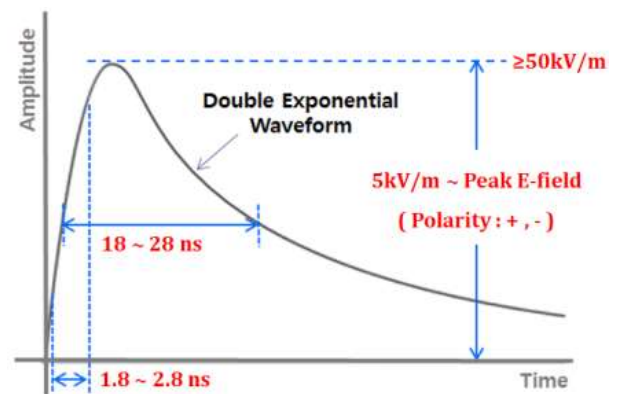

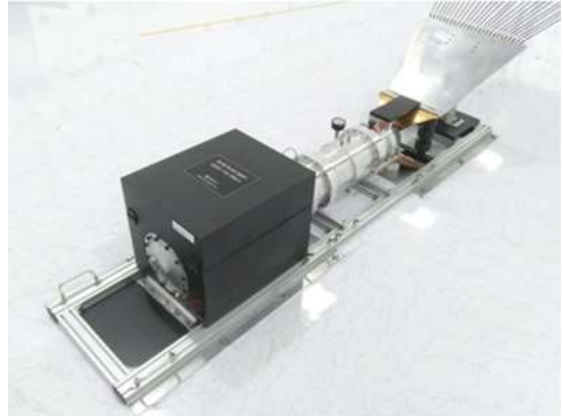
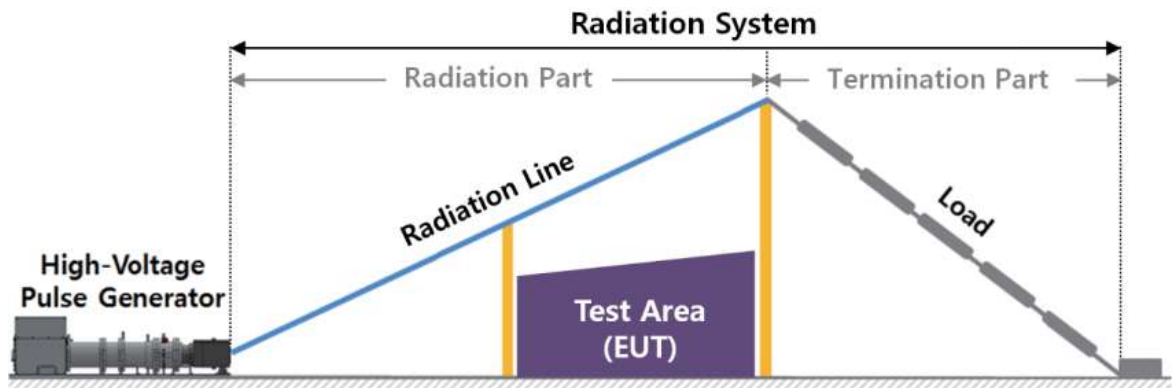

■ Specifications

Parameter	Value
Model Name	NEMP-TTG-250KV
Standard	MIL-STD-461 E/F/G RS-105
Pulse Generator Voltage Range(Open Circuit)	100kV~250kV
Radiating Line Type/Impedance	Transmission Line/110Ω
Termination Type	Distributed Resistance
E-field waveform	Double exponential
E-field Pulse Rise Time(10%~90%)	1.8ns ~ 2.8ns
E-field Pulse Width(FWHM)	18ns ~ 28ns
Max. E-field Strength	50kV/m or more
E-field Polarization	Vertical
E-field Polarity	Positive(+), Negative(-)
Pulse Repetition Rate	1/min
Insulation of HV Pulse Generator	N2 & Insulation oil
Power Rating	220VAC / 50Hz~60Hz
Storage/Working Temperature	5°C~50°C / 15°C~45°C
Dimension(L×W×H)	15m × 5m × 3.6m
Max. Test Volume(L×W×H)	1m × 1m × 1m
Weight	~150kg

■ Recommendation

The distance between top of the radiating line and the closest metallic ground(including ceiling, shielded room walls, and so forth) should be at least 2 times of the maximum height of the radiating line by the MIL-STD-461 E/F/G RS105. And, the installation is recommended with the clearance distances as the following table and diagram to avoid distortions from reflections.

■ NEMP Simulator Size

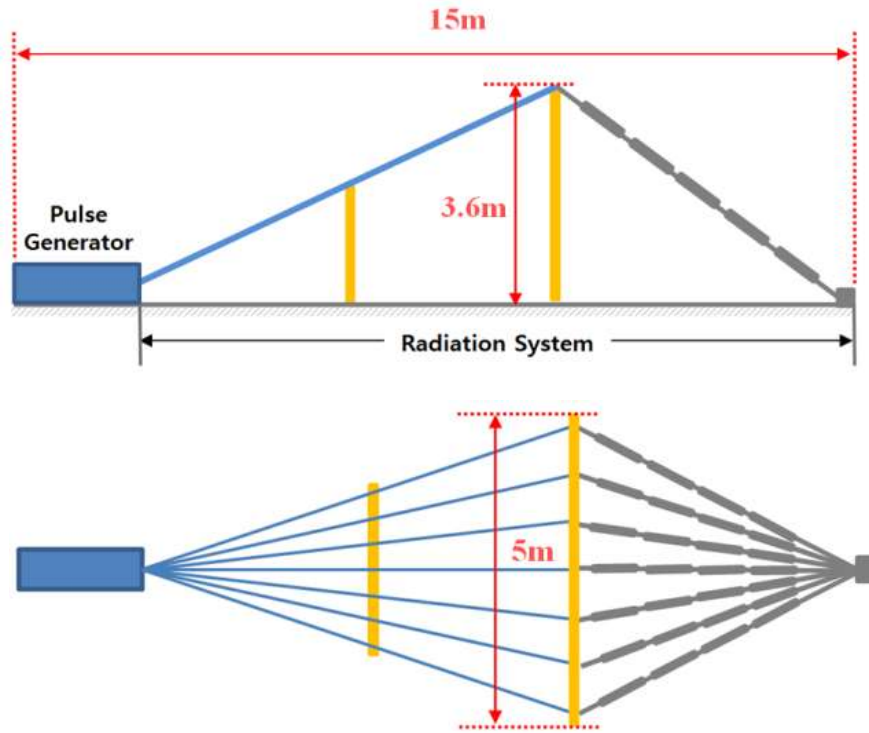

■ Test Volume Size

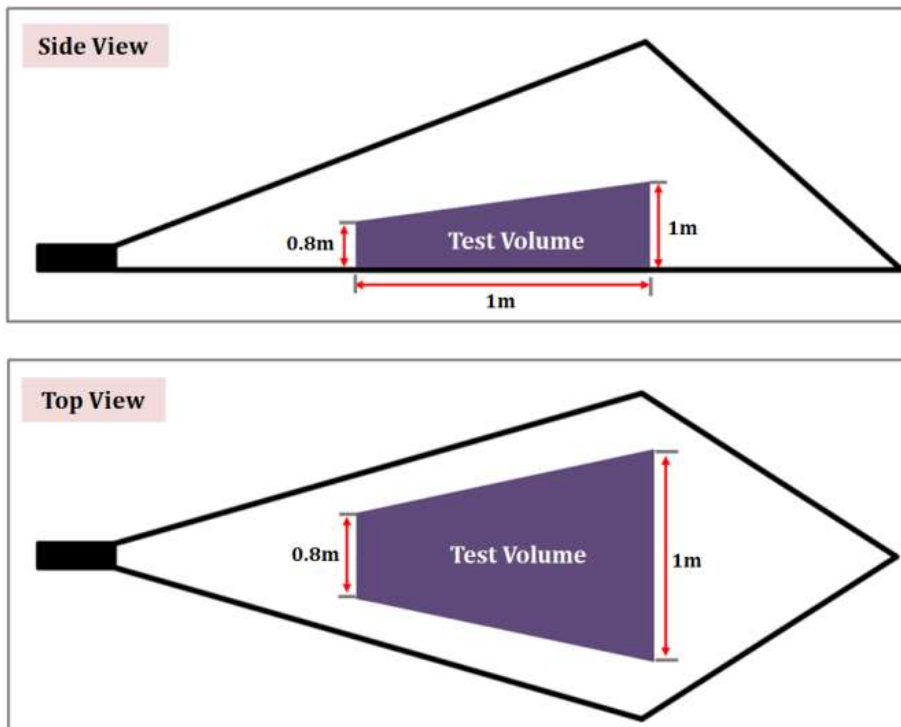

■ Minimum Recommended Clearance Distances

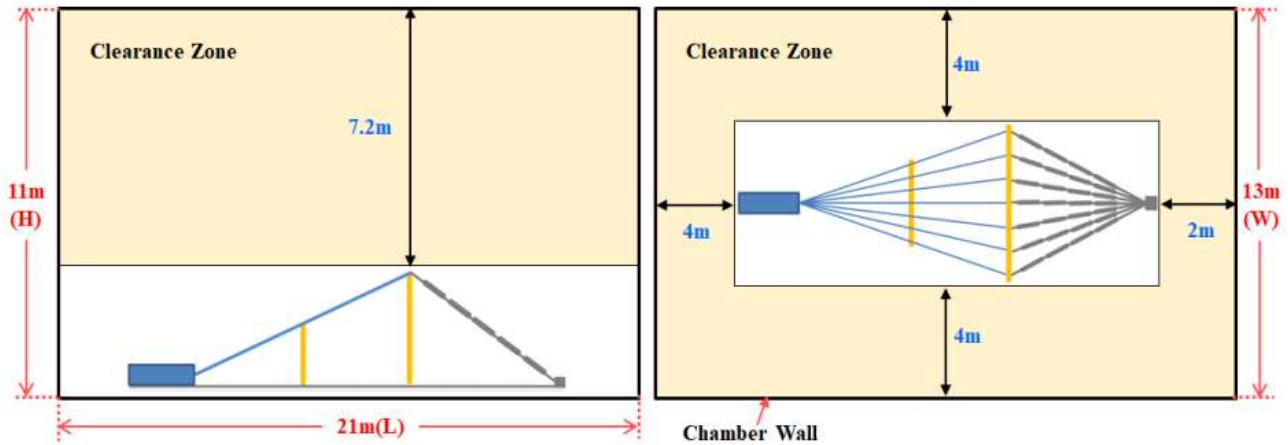

Parameter	Length(m)	Width(m)	Height(m)
NEMP Simulator Dimension	15	5	3.6
Anechoic Chamber Dimension	21	13	11
Max. Test Volume Size	1	1	1

■ NEMP Simulator(NEMP-TTG-250kV) E-field Measurement Results

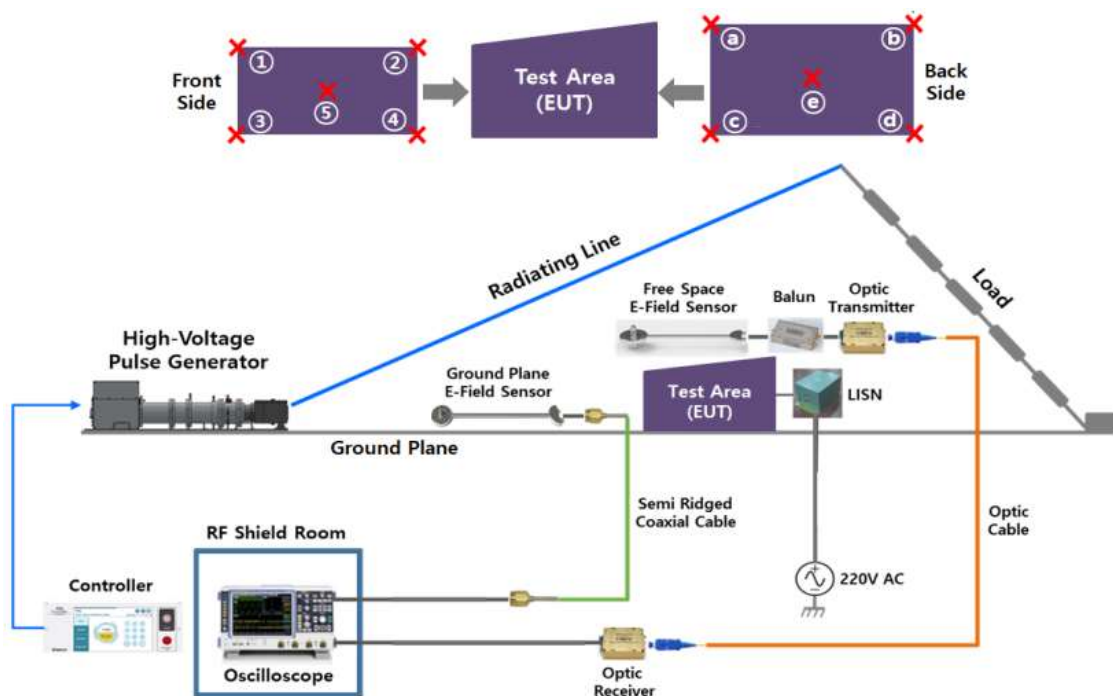

### ■ Plus(+) Polarity E-field Measurement Results

5kV/m Set	Item	Front Side					Item	Back Side				
		⑤	①	②	③	④		e	a	b	c	d
	E-field(kV/m)	9.17	7.56	7.46	6.99	7.37	E-field(kV/m)	5.04	5.17	5.37	5.50	5.73
Rise Time(ns)	2.11	2.56	2.61	1.89	1.83	Rise Time(ns)	2.33	2.28	2.33	1.83	1.94	
Pulse Width(ns)	21.0	20.89	21.44	20.56	20.55	Pulse Width(ns)	20.78	19.16	18.61	20.61	20.94	

25kV/m Set	Item	Front Side					Item	Back Side				
		⑤	①	②	③	④		e	a	b	c	d
	E-field(kV/m)	40.63	44.3	48.47	40.5	40.33	E-field(kV/m)	27.47	27.8	26.3	27.23	26.9
Rise Time(ns)	2.39	2.44	2.39	1.88	2.0	Rise Time(ns)	2.22	2.28	2.28	2.28	2.56	
Pulse Width(ns)	19.78	20.44	21.44	20.72	21.61	Pulse Width(ns)	18.66	19.17	18.89	21.11	21.17	

50kV/m Set	Item	Front Side					Item	Back Side				
		⑤	①	②	③	④		e	a	b	c	d
	E-field(kV/m)	92.35	96.02	90.02	70.9	72.07	E-field(kV/m)	69.35	59.05	62.72	50.77	54.75
Rise Time(ns)	2.11	2.11	2.22	2.23	2.06	Rise Time(ns)	2.11	2.05	2.11	1.84	2.18	
Pulse Width(ns)	19.05	20.39	20.17	22.12	21.18	Pulse Width(ns)	20.33	18.17	18.55	18.95	20.9	

### ■ Minus(-) Polarity E-field Measurement Results

-5kV/m Set	Item	Front Side					Item	Back Side				
		⑤	①	②	③	④		e	a	b	c	d
	E-field(kV/m)	-8.7	-8.23	-8.83	-6.57	-6.64	E-field(kV/m)	-6.2	-5.57	-5.42	-5.4	-5.34
Rise Time(ns)	2.06	2.11	2.22	2.0	1.94	Rise Time(ns)	2.17	1.83	2.0	1.94	2.22	
Pulse Width(ns)	20.83	21.06	21.22	21.22	21.0	Pulse Width(ns)	20.72	18.77	18.72	21.0	20.33	

-25kV/m Set	Item	Front Side					Item	Back Side				
		⑤	①	②	③	④		e	a	b	c	d
	E-field(kV/m)	-45.47	-49.43	-45.43	-40.42	-39.25	E-field(kV/m)	-27.67	-28.0	-28.17	-25.42	-26.75
Rise Time(ns)	2.72	2.61	2.77	2.33	2.38	Rise Time(ns)	2.66	2.5	2.61	2.28	2.05	
Pulse Width(ns)	21.11	20.94	21.17	19.33	21.06	Pulse Width(ns)	20.05	19.33	19.44	19.72	19.06	

  

-50kV/m Set	Item	Front Side					Item	Back Side				
		⑤	①	②	③	④		e	a	b	c	d
	E-field(kV/m)	-90.51	-92.14	-89.8	-75	-73.03	E-field(kV/m)	-61.16	-56.49	-59.49	-50.6	-50.0
Rise Time(ns)	1.89	2.11	2.11	1.95	1.88	Rise Time(ns)	2.22	2.28	2.22	2.05	2.05	
Pulse Width(ns)	19.83	20.22	19.78	20.95	21.28	Pulse Width(ns)	19.67	18.5	19.28	19.94	19.33	

■ Measurement Waveform : Positive, 5kV/m(Minimum E-field Strength)



■ Measurement Waveform : Negative, 5kV/m(Minimum E-field Strength)

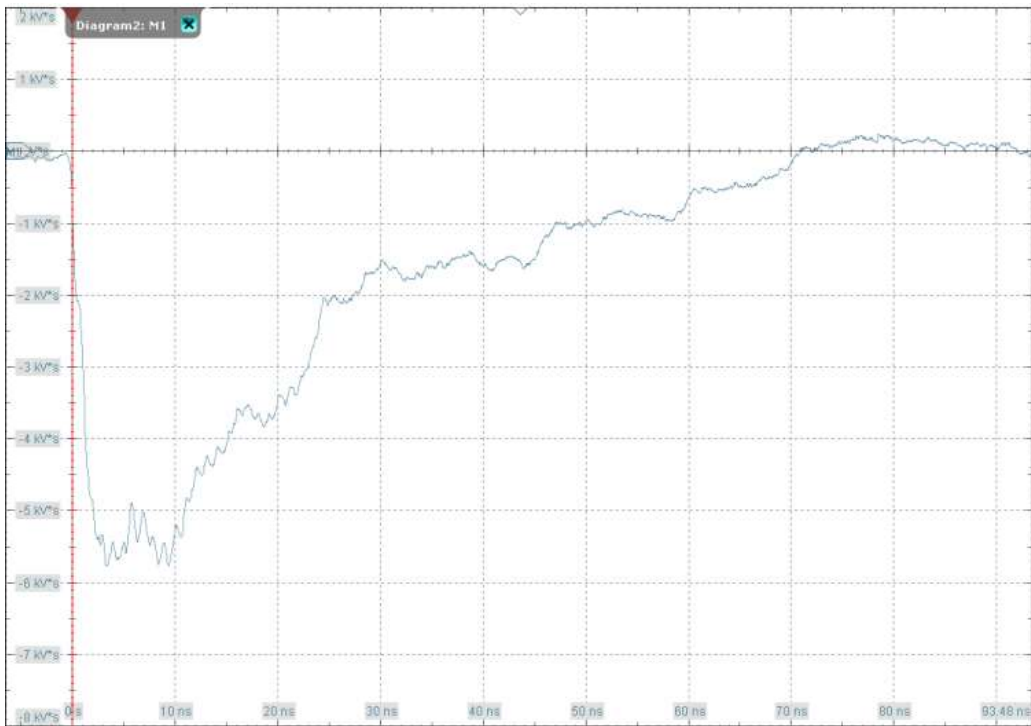

■ Measurement Waveform : Positive, 20kV/m

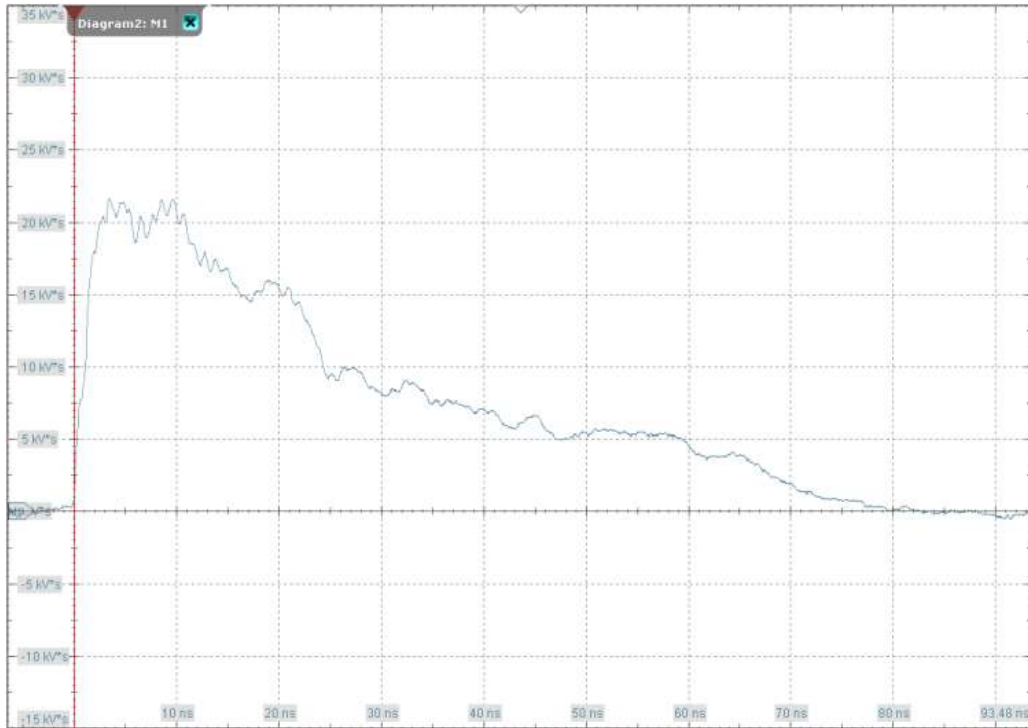

■ Measurement Waveform : Negative, 20kV/m

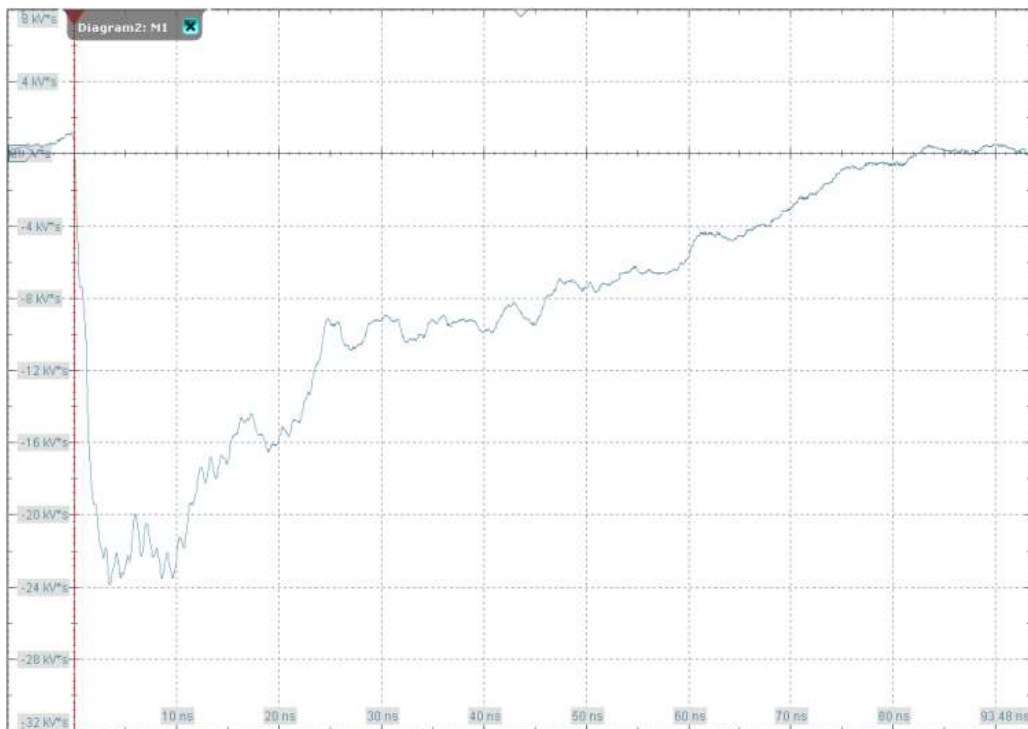



■ Measurement Waveform : Positive, 50kV/m(Maximum E-field Strength)



■ Measurement Waveform : Negative, 50kV/m(Maximum E-field Strength)

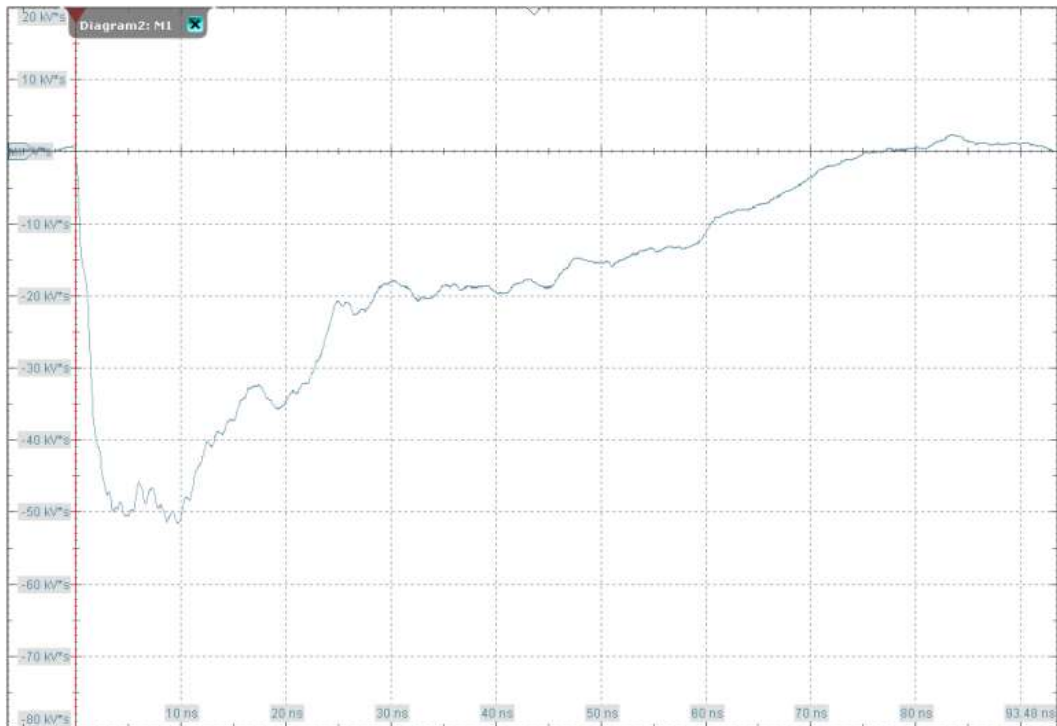

## NEMP Simulator Test & Measurement Configuration

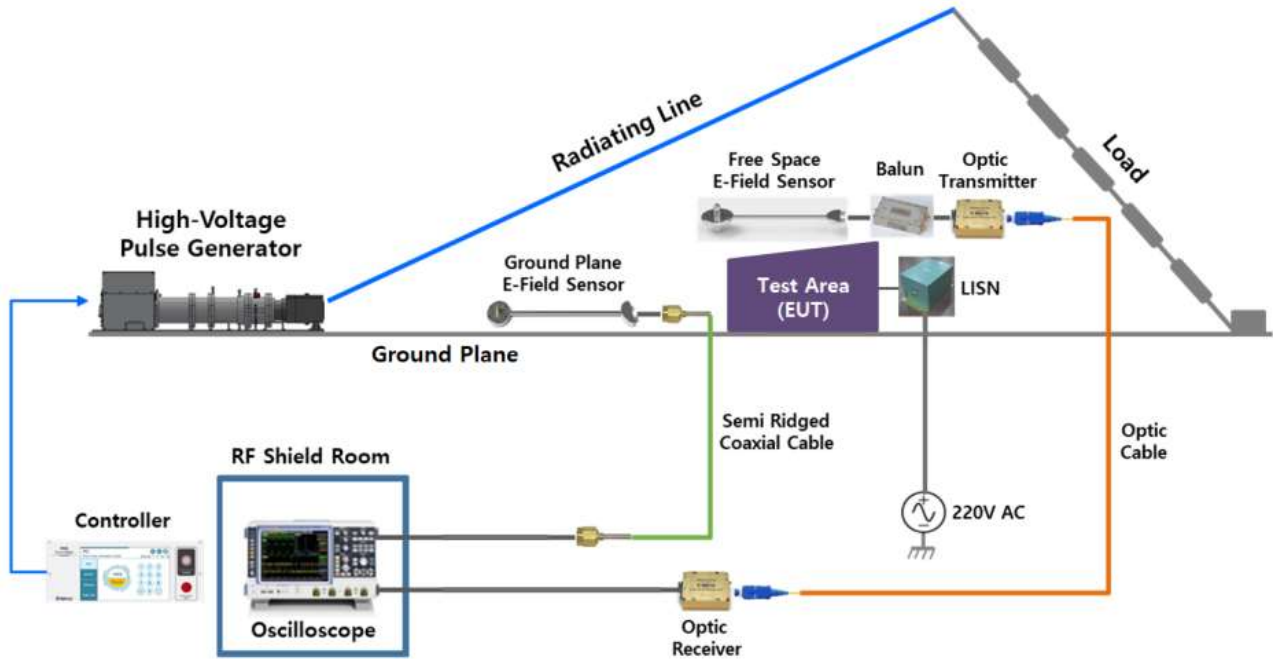

### 1. E-field Monitor System

- E-field monitor system is configure of the Free Space E-field monitor system and Ground Plane E-field monitor system.

#### ● Free Space E-field Monitoring System

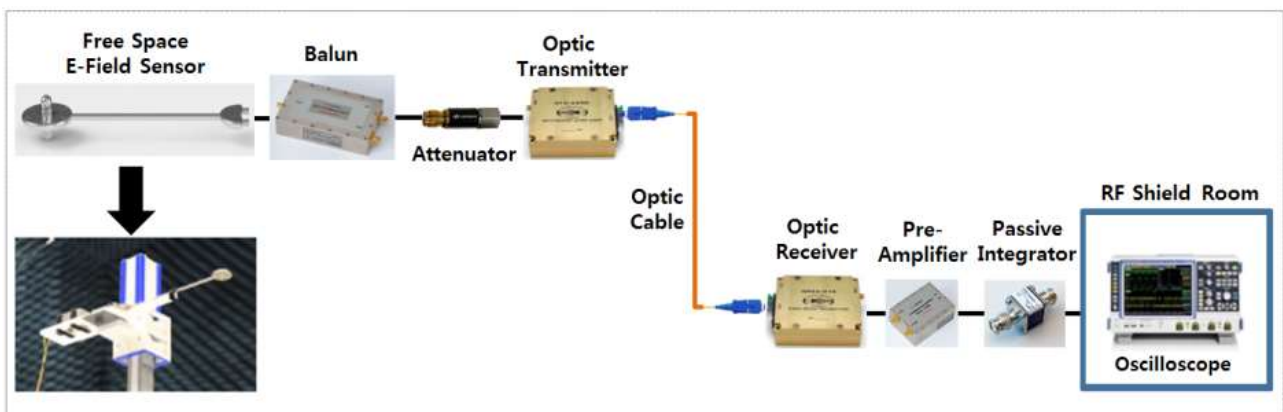

[ Free Space E-field Monitoring System ]

- Free space E-field monitor are made of derivative field sensors which can be place anywhere

under the transmission line and are connected to the oscilloscope through optical link.

- Since the free space E-field sensor(D-dot sensor) has the characteristics to derivative the acquired waveform, it can be restored by connecting an passive integrator(H/W) to the oscilloscope's input channel or by means of a mathematical integral(S/W) of the oscilloscope's measured waveforms via the sensor.

#### ● Ground Plane E-field Monitor System

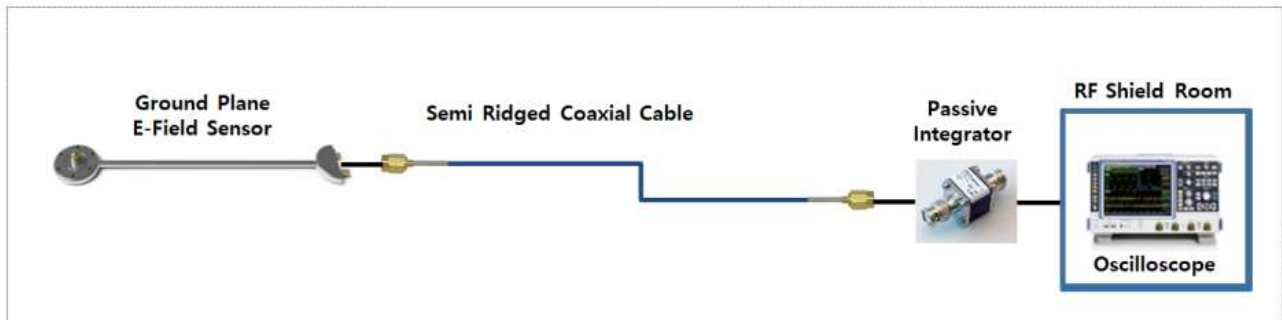

[ Ground Plane E-field Monitoring System ]

- Ground plane E-field monitor are made of derivative field sensors directly placed on the ground plane and are connected to the oscilloscope through coaxial cables and passive integrators. we recommend using a measurement with passive integrator.

## 2. Device Protection System

#### ● RF Shield Room(or Shield Box)

- It is recommended that the oscilloscope be installed and operated inside a shield room or shielded box to protect it from the powerful noise generated by the operation of the EMP generator.

#### ● LISN

- The LISN(Line Impedance Stabilization Network) are used to provide standardized impedance in common mode to the lines connected to the EUT.